

17C.123 FORM BASED CODE ZONES

The proposed amendments to the Hamilton Form-Based Code (FBC) is an area-specific Spokane Municipal Code Text Amendment that implement recommendations from the [South Logan TOD Plan](#). These changes are intended to make strategic adjustments to the existing FBC to enhance transit-oriented development opportunities, while retaining standards that ensure future development is pedestrian-oriented and contributes to the area. The proposal includes consolidating the context areas and street types within the area to improve useability and predictability, identifying Shopfront designations for targeted intensity, integrating visual regulations into standard tables and code format, and general reorganization. The reorganization of the code has resulted in large sections of the Hamilton FBC to be “repealed” and relocated, as noted in the text amendment tracking sheet.

*Text with ~~((**strikethrough**))~~ is proposed to be repealed/modified with underlined text representing proposed text. Text without a strikethrough or underline is existing and not proposed to be modified.*

Section 1. That SMC Section 17C.123.010 is amended to read as follows:

Section 17C.123.010 Purpose

~~((The form-based zoning categories implement the centers and corridors goals and policies and land use map designations of the comprehensive plan. This form-based code))~~ The Hamilton Form-Based Code (FBC) is designed to foster an economically vibrant, walkable, mixed-use environment along the Hamilton Street corridor within the boundaries of the code. This code regulates land development by setting careful and coherent controls on building form, coupled with performance-based parameters relative to building use and ~~((density))~~ intensity. ~~((This greater emphasis on physical form is intended to produce safe, attractive and enjoyable public spaces, including a healthy mix of uses.))~~ Through emphasis on physical form, the Hamilton FBC promotes connectivity and livability with safe, accessible public spaces, a healthy mix of uses, and access to transit.

~~((The FBC is a pilot program and is configured as a plug-in set of regulations, replacing existing zoning and design guidelines within the FBC Limits. This pilot program is consistent with the Logan Identify Plan. All code provisions expressed herein present development requirements unless otherwise indicated, including information preceded by the word “Guidelines.” Additional, specific City of Spokane standards may be required as referenced.))~~

Where not otherwise regulated within this Chapter, development within the Hamilton FBC area shall meet all applicable regulations of the Spokane Municipal Code.

Section 2. That SMC Section 17C.123.020 is amended to read as follows:

17C.123.020 ((~~Code Organization~~)) Context Area and Store Front Designations

~~((Using this code: Criteria for development within the code boundaries is expressed in six sections. Use of the FBC, relating to each of these sections, is described below:~~

~~A. Regulating & Street Section Plans.~~

~~Find the property of interest, noting its location relative to the “Context Areas” established by the Regulating Plan, as well as the location of any “Shopfront Streets” abutting the property. These elements direct many of the allowances provided in the FBC.~~

~~B. Height, Placement & Coverage.~~

~~Using criteria from the Regulating Plan, note the allowed maximum building heights; build-to-lines; minimum building frontages, and impervious surface coverage allowances detailed in this section.~~

~~C. Parking Criteria & Site Access.~~

~~Using criteria from the Regulating Plan and the Street Section Plan, note the various allowances regarding off-street surface parking, lot placement, lot and site lighting.~~

~~D. Streetscape Requirements.~~

~~Using type criteria from the Street Section Plan, note the basic configuration and feature specifications for sidewalks and pedestrian buffer zones within the FBC Limits.~~

~~E. Architectural Requirements.~~

~~Using criteria from the Regulating Plan, note the various façade treatments, screening, detailing and other requirements specific to the appearance and public-realm function of buildings.~~

~~F. Additional Requirements.~~

~~This section identifies additional requirement not covered by the HFBC.~~

~~G. Building Type Catalogs.~~

~~This section provides a visual catalog of desired building characteristics.))~~

The Hamilton Form-Based Code (FBC) area is regulated by a Context Area. Identified intersections are assigned Shopfront designations, which include additional requirements and allowances.

A. Context Area.

Context Area 1 (CA1) is the implementing zone of the Hamilton FBC. Figure 17C.123.010-A illustrates the location of the C1 zoning.



Figure 17C.123.010-A
Context Area Map

B. Shopfront Designations.

Shopfront designations are assigned to key intersections within the Hamilton FBC to allow for increased height and pedestrian-oriented design. Figure 17C.123.010-B illustrates the location of the Shopfront designations.



**Figure 17C.123.010-B
Shopfront Designations**

Section 3. That SMC Section 17C.123.030 is amended to read as follows:

17C.123.030 ((Regulating & Street Section Plans)) Building Form

~~((This section provides and describes the FBC Regulating Plan and Street Section Plan – two map illustrations showing the location and limits of various features and physical characteristics required under this code. The Regulating Plan also indicates placement and extents of “Shopfront Street” areas, triggering specific use, building placement and other requirements.~~

A. ~~Regulating Plan.~~

~~The Regulating Plan for the FBC is included here as Figure 17C.123.030-1, and provides the organizing framework for many of the requirements described herein. The Regulating Plan divides land within the code boundaries into four distinctive context areas and identifies shopfront streets, listed and described as follows:~~

- ~~1. **CA 1: Context Area 1 provides for and supports the most intense development patterns, generally allowing greater height and building intensities than other context areas. CA-1 is intended to grow as a mixed-use center and focal point for the neighborhood and corridor, supporting significant commercial offerings, service activities, and high-density housing.**~~

- ~~2. CA-2: Context Area 2 provides for and supports mid-range development intensities, allowing somewhat lesser height and building intensities than CA-1. CA-2 is intended to grow as a second-tier mixed-use center for the neighborhood and corridor, supporting commercial offerings, service activities, and high-density housing.~~
- ~~3. CA-3: Context Area 3 provides for and supports low to mid-range development intensities, allowing lesser height and building intensities than CA-1 or CA-2. CA-3 is intended to grow as a second-tier mixed-use area for the neighborhood and corridor, providing continuity along Hamilton by linking CA-1 and CA-2, while at the same time acting as a transition zone between the corridor environment and CA-4 and neighborhood areas immediately outside the HFBC Limits.~~
- ~~4. CA-4: Context Area 4 provides for and supports low to mid-range development intensities, allowing lesser height and building intensities than other context areas. CA-4 is intended to grow as a third-tier mixed-use area for the neighborhood and corridor, acting as a transition zone between the corridor environment and lower-density residential development immediately outside the FBC Limits. Though a mix of uses are allowed in CA-4, the area is envisioned as generally residential in scale and character.~~
- ~~5. Shopfront Street: provides for areas where specific uses, building placement, and other requirements apply. The shopfront street is generally applied to areas where business or retail use level with and directly along the public right-of-way is seen as critical.~~

~~B. Street Section Plan.~~

~~The Context Area Zones are complemented by the Street Section Plan which is included here as Figure 17C.123.030-2 and guides public and private development within the FBC Limits. The Street Section Plan defines four section types and describes amenities based upon the intended use, desired qualities, and community objectives. Right-of-ways shall not be vacated as the space is needed to incorporate the elements described in street designations below. Curb to property line and the sidewalk width shall not be reduced in order to allow for future Street Section elements. The four section types are listed and generally described in order of intensity, as follows:~~

- ~~1. Street Type 1 (Hamilton Street): Type 1 provides for and supports a mixed-use corridor environment (CA-1, CA-2, CA-3). Type 1 streets have wide, well-maintained sidewalks and pedestrian amenities to encourage strolling, walking, and shopping. They maintain a Planting Zone and Clear Pedestrian Zone on each side of the street.~~

2. ~~Street Type 2 (Mission Avenue): Type 2 provides for and supports a blend of mixed-use and residential environments (CA-1, CA-4). Type 2 serves existing east/west arterial needs, and includes a median with turn lanes (at Hamilton), a Planting Zone and Clear Pedestrian Zone on each side of the street.~~

3. ~~Street Type 3 (Includes Sinto, Sharp, Boone): Type 3 provides for and supports a mixed-use district environment (CA-2, CA-3, CA-4). Type 3 includes a Planting Zone and Clear Pedestrian Zone on each side of the street.~~

4. ~~Street Type 4 (Includes Augusta and Dakota): Type 4 provides for and supports an environment bridging between mixed-use and residential areas (CA-4). Type 4 includes a Planting Zone and Clear Pedestrian Zone on each side of the street.))~~



~~((Figure 17C.123.030-1 Regulating Plan for the Form Based Code))~~

[NOTE: Delete graphic above]

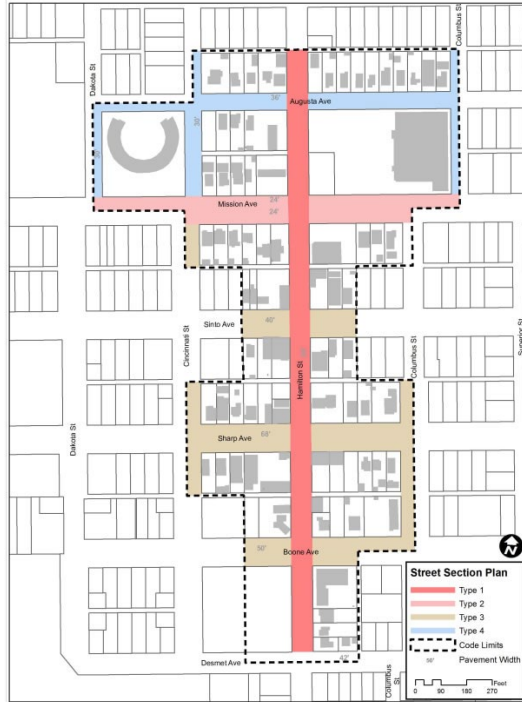

((Figure 17C.123.030-2 Street Section Plan for the Form Based Code))

[NOTE: Delete graphic above]

Within the Hamilton Form-Based Code (FBC), an emphasis is placed on building form and location in order to ensure a vibrant mixed-use environment that supports a range of transportation options, including transit, walking, and rolling.

A. Building Form Standards.

Table 17C.123.030-1 Hamilton FBC Building Form		
	<u>CA1</u>	<u>Shopfront</u>
<u>Maximum Height [1]</u>	<u>75 ft.</u>	<u>150 ft.</u>
<u>Impervious Surface Maximum</u>	<u>100%</u>	<u>100%</u>
<u>Setbacks</u>		
<u>Minimum Front Setback [2]</u>	<u>0 ft.</u>	<u>0 ft.</u>
<u>Maximum Front Setback [2] [3]</u>	<u>15 ft.</u>	<u>0 ft.</u> <u>10 ft. along Hamilton</u>
<u>Minimum Interior Side Lot Line</u>	<u>0 ft.</u>	
<u>Minimum Interior Side Lot Line – adjacent to RMF or RHD</u>	<u>5 ft.</u>	
<u>Minimum Rear</u>	<u>0 ft.</u>	

[1] Development of 70 feet or more shall meet all applicable requirements of SMC 17C.250 Tall Building Standards.

[2] When the existing sidewalk width is less than 12 feet, structures shall be allowed no closer than 12 feet from the back of the curb.

[3] A public plaza meeting all requirements of SMC 17C.123.030C(1)(2)(i) may extend the maximum setback an additional 10 feet

B. Height.

1. Building height is the vertical distance from the average grade to the highest point of the roof or structure.

2. Height Exceptions.

a. Pitched roofs may extend above the height limit, but if the space within the pitched roof is habitable, it shall only be used for residential purposes.

b. For flat roofs, open roof structures (pergolas, arbors) and architectural roof structures (turrets, etc.) may extend beyond the height limit by no more than 12'.

c. For flat roofs, enclosed roof structures (penthouses) may extend above the height limit by no more than 18' from the roof line if set back at least 20' from all street lot lines.

C. Building Placement.

1. Shopfront Designations.

a. Building placement along Shopfront Streets shall prioritize street corner locations, precluding the development of parking, open spaces, or other lot features at street corners.

b. Exceptions.

i. Public Plaza.

A plaza or courtyard, with a minimum area of four hundred square feet or two percent of the total interior floor space of the development, whichever is greater, may be located between a building and the street corner so long as the plaza:

a. is a level space accessible to the public;

b. is at least ten feet in width;

c. is within thirty inches of the grade of the sidewalk providing access to it;

d. has no more than sixty percent of the area covered in vegetation; and

- e. includes seating, pedestrian-scale lighting, decorative paving, and other pedestrian furnishings.

Section 4. That SMC Section 17C.123.040 is amended to read as follows:

17C.123.040 ((~~Land Use, Height, Placement and Parking~~)) Permitted Uses

~~((This section provides a broad range of allowable use categories within the Regulating Plan limits, specifying permitted and prohibited uses according to building story reflecting the development patterns expressed in the Regulating Plan. This section also regulates building height, placement, frontage and impervious surface coverage, specifying each within the Context Areas provided in the Regulating Plan and managing the transition between high-intensity mixed-use areas and low-intensity residential areas outside the limits of this form-based code. This section also regulates parking, parking lot location and treatment, and site lighting, consistent with the Regulating Plan. Conformance with these standards is critical to establishing the type of pedestrian and vehicular access patterns needed for the area to thrive as a vibrant, walkable district.~~

~~A. Use Provisions.~~

~~Use regulations are provided in figures 17.123.040-D through 17.123.040-G for all areas within the Regulating Plan. Uses deemed unsuitable for areas within the Regulating Plan area are specifically identified.~~

~~B. Building Height.~~

~~The height of buildings shall be measured from mean grade to top of cornice or roof eave and shall meet the specifications provided in figures 17.123.040-D through 17.123.040G. Building height measurements express regulatory standards.~~

- ~~1. Maximum height limits in CA-1, CA-2, and CA-3 are allowed only within 100' to 114' of the Hamilton right of way line to match the platting pattern along Hamilton. Beyond 100' from Hamilton, proposals shall be designed with respect for the height, scale and character of adjacent zone as described in Figure 17C.123.040-A:))~~

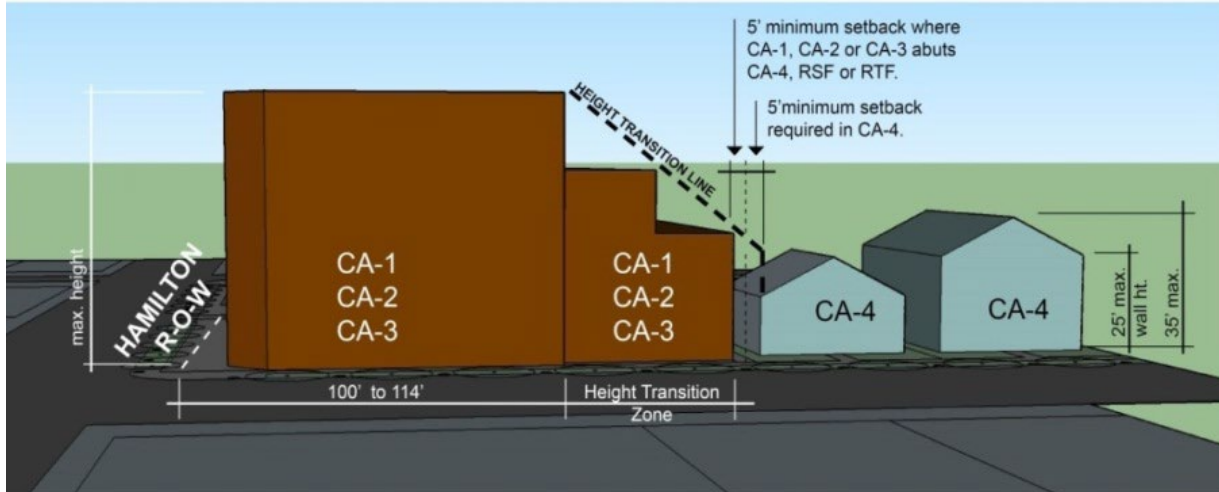

((Figure 17C.123.040A: The maximum height designation for CA-1, CA-2, CA-3 is allowed within 100' to 114' of the Hamilton right of way line to match the platting pattern along Hamilton. Beyond this point, the maximum height may not exceed a transition line to the maximum wall height allowed in the adjacent zone.))

[NOTE: Delete graphic above]

~~((C. Story listings are provided for reference purposes only, expressing typical outcomes for listed heights. Allowable height exceptions apply to the overall distance extending beyond the measured building height, as follows:~~

- ~~1. Pitched roofs may extend above the height limit, but if the space within the pitched roof is habitable, it shall only be used for residential purposes.~~
- ~~2. For flat roofs, Open Roof Structures (pergolas, arbors) and Architectural Roof Structures (turrets, etc.) may extend beyond the height limit by no more than 12'.~~
- ~~3. For flat roofs, enclosed structures (penthouses) may extend above the height limit by no more than 18' from the roof line if set back no less than 20'.~~

~~D. Shopfront Street Provisions.~~

~~Building placement along Shopfront Streets shall prioritize street corner locations, precluding the development of parking, open spaces or other lot features at street corners.~~

~~E. Impervious Surface Coverage.~~

~~Impervious surfaces shall not exceed the maximum impervious surface percentages (calculated on the basis of the lot) specified in Table 17C.123.040-4.))~~

((Table 17C.123.040-1 Impervious Surface Coverage				
	CA-1	CA-2	CA-3	CA-4
Maximum Impervious Surface	90%	80%	70%	50%))

~~((F.—Parking~~

- ~~1.—Off-Street Surface Parking: Off-street surface parking shall not be placed between the street right-of-way and the building fronting the street.~~
- ~~2.—Parking Space and Aisle Dimensions: Standards for parking space and aisle dimension can be found in SMC 17C.230.140.~~
- ~~3.—Bicycle Parking: Requirements for bicycle parking are found in SMC 17C.230.200. Bicycle parking provided in the streetscape can contribute to requirements in SMC 17C.230.200.~~
- ~~4.—Other Provisions: Additional parking requirements are stated in 17C.230 SMC, Parking and Loading. The FBC supersedes the location and amount requirements for parking; these standards are identified for each context area in figures 17.123.040-D through 17.123.040-G.~~

~~G.—Surface parking and site lighting.~~

~~Surface parking lot and site lighting shall contribute to the character and safety of the site and adjacent rights of way, while not disturbing adjacent properties. Surface lot and site lighting shall adhere to the following standards:—~~

- ~~1.—Lighting types—Pedestrian-scale fixtures shall be used for all lighting illuminating required Pedestrian Paths. Vehicle-scale fixtures may be used for general surface lot and site lighting. (See Figure 17C.123.040-B)~~
- ~~2.—Performance—Parking lot and site lighting shall provide adequate night visibility and security by distributing a minimum of two foot-candles to a maximum of six foot-candles of illumination at ground level. All lighting shall be shielded from producing off-site glare, directing light downward and away from adjacent properties.~~
- ~~3.—Driveways/Site Access—Driveway widths shall not exceed 24 feet, and curb cuts shall not exceed 30 feet for combined entry/exits.—~~
- ~~4.—Pedestrian Walkways—Within surface lots containing more than 30 parking stalls, pedestrian-friendly walkways shall be provided between the surface lots and building entrances. Pedestrian Paths shall be not less than five feet wide and be clearly defined, using at least two of the following:—~~
 - ~~a.—Six-inch vertical curbing~~
 - ~~b.—Textured paving, including across vehicle lanes~~

c. ~~Continuous landscaped area at a minimum of 3 feet wide on at least one side of the walkway~~

H. ~~Shopfront Street Provisions – If fronting on a Shopfront Street, above-ground parking structures shall provide continuous ground-level commercial or office spaces and uses along the street, except at ingress and egress points into the structure. (See Figure 17C.123.040-C).)~~

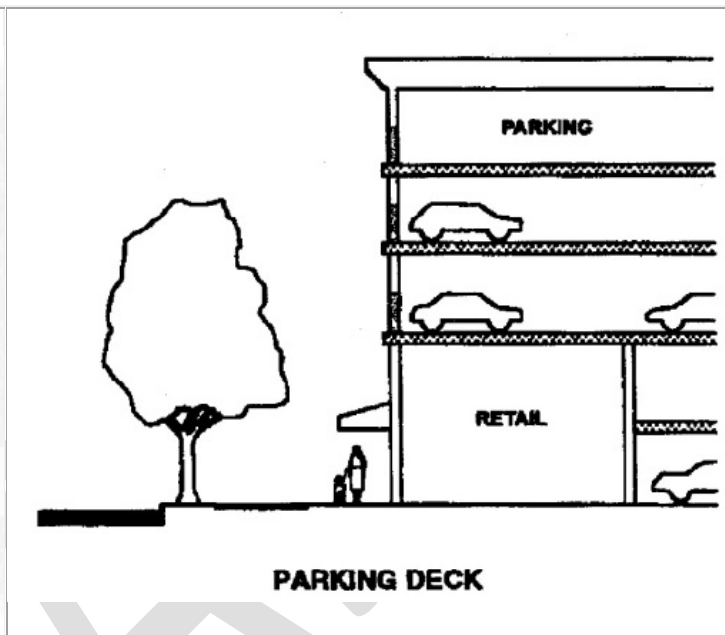
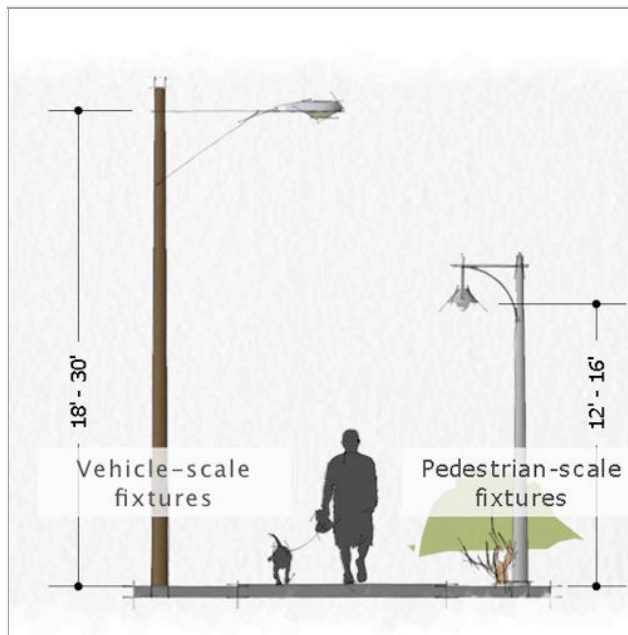

~~((Figure 17C.123.040-B: Unless otherwise specified, Vehicle-Scale and Pedestrian Scale lighting fixtures must meet height criteria illustrated here.))~~

~~((Figure 17C.123.040-C: Parking garages (decks) along shopfront streets must provide ground-level retail, commercial or office space fronting the street.))~~

~~[NOTE: Delete graphic above]~~

~~[NOTE: Delete graphic above]~~

~~((I. Regulatory Cutsheets – The information presented in the tables in figures 17.123.040-D through 17.123.040-G represent the regulations for height, parking, land uses, build-to-lines, and building frontage for all Context Areas.~~

~~J. Figure 17C.123.040-H supplements the regulatory cutsheets by providing visual representation for build-to-lines, interior lot lines and other standards.))~~

Figure 17C.123.040-D
Context Area 1 (CA-1)

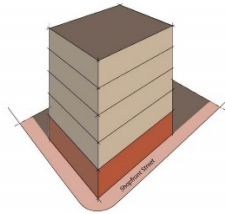

Images above are representational only and are not to be considered regulatory. The Rendering Plan, this chapter's general provisions and the information contained in this table to the right constitute the regulatory framework related to land use, height, parking, back to line, coverage and frontage.

¹Build-to-line shall establish a 12-foot minimum and up to 22' maximum space from the back of the curb to the building along Street Type 1. If existing width is less than 12' structures shall be allowed no closer than 12' from the back of the curb.

Shoptone within 100' 114' of rear from property line	66' (five stories)	Height max.
Beyond 100' 114' Hamilton property line	Transition Standards as identified in 17C.123.060-A	
Maximum surface parking	2 spaces/500' of floor area	Parking
Landscaping	See Section SAC 17C.200	
Location	To side or rear of building	
Additional Parking Requirements	See Sections: SAC 17C.230.100 SAC 17C.230.120 SAC 17C.230.130 SAC 17C.230.140 SAC 17C.230.200	
Residential, except where prohibited		Land Uses
Non-residential all floors		
Prohibited uses	Single-family detached and townhouses Multi-unit residential, storage or warehouse Adult businesses Residential uses on adjacent street (ground floor) Structural parking on adjacent street (ground floor) Auto-related uses Drive-through facilities	
Street Type 1	3'-6" - 12'-0"	Build-to-line
Street Type 2 and 4	0'	
When within 50' of CA-1	0'	
Street Type 3	Not applicable	
Alley	0'	Setback from
Interior lot line	0'	
Interior lot line if abutting CA-4	0'	
Street Type 1	80%	Building coverage from
Street Type 2	60%	
Street Type 3	N/A	
Street Type 4	0%	

[NOTE: Delete graphic above]

Figure 17C.123.040-E
Context Area 2 (CA-2)

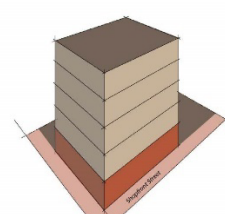

Images above are representational only and are not to be considered regulatory. The Rendering Plan, this chapter's general provisions and the information contained in this table to the right constitute the regulatory framework related to land use, height, parking, setbacks and frontage.

¹Build-to-line shall establish a 12-foot minimum and up to 22' maximum space from the back of the curb to the building along Street Type 1. If existing width is less than 12' structures shall be allowed no closer than 12' from the back of the curb.

Shoptone within 100' 114' of rear from property line	66' (five stories)	Height max.
Beyond 100' 114' Hamilton property line	Transition Standards as identified in 17C.123.060-A	
Maximum surface parking	2 spaces/500' of floor area	Parking
Landscaping	See Section SAC 17C.200	
Location	To side or rear of building	
Additional Parking Requirements	See Sections: SAC 17C.230.100 SAC 17C.230.120 SAC 17C.230.130 SAC 17C.230.140 SAC 17C.230.200	
Residential, except where prohibited		Land Uses
Non-residential all floors		
Prohibited uses	Single-family detached and townhouses Multi-unit residential, storage or warehouse Adult businesses Residential uses on adjacent street (ground floor) Structural parking on adjacent street (ground floor) Auto-related uses Drive-through facilities	
Street Type 1	3'-6" - 12'-0"	Build-to-line
Street Type 2	0'	
Street Type 3	0'	
When within 50' of CA-1	0'	
Street Type 4	Not applicable	
Alley	0'	Setback from
Interior lot line	0'	
Interior lot line if abutting CA-4	0'	
Street Type 1	80%	Building coverage from
Street Type 2	60%	
Street Type 3	N/A	
Street Type 4	N/A	

[NOTE: Delete graphic above]

Figure 17C.123.040-F
Context Area 3 (CA-3)

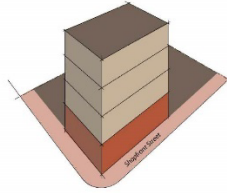

Images above are representational only and are not to be considered regulatory. The Regulatory Plan, this chapter's general provisions and the information contained in the table to the right control over the regulatory framework related to land use, height, parking, setbacks, building form, coverage and formage.

¹ Build-to-line shall be a minimum of 12 feet minimum and up to 22' maximum space from the back of the curb to the building along Street Type 1. If existing width is less than 12' setbacks shall be allowed no closer than 12' from the back of the curb.

Shoofront of 2 to 100' - 114' of front from property line	54' (floor slates)	Height max.
Beyond 100' - 114' Shoofront	Transitions 5' increments as identified in 17C.123.040-A	
Minimum off-street parking	2 spaces/100 of floor area	Parking
Landscaping	Section SMC 17C.200	
Location	To side or rear of building	Land Uses
Additional Parking Requirements	See Sections SMC 17C.200.100 SMC 17C.200.120 SMC 17C.200.130 SMC 17C.200.140 SMC 17C.200.200	
Residential	Residential, except where prohibited	Build-to-line
Non-Residential	Non-Residential all floors	
Prohibited uses:	Highly toxic materials and hazardous wastes Aerobic wastes, storage or combustion All businesses Recreational uses except sports ground Retail uses Auto repair shops Drive Through Facilities	Setback min.
Street Type 1	None	
Street Type 2	None	
Street Type 3, 4	None	
Alley	None	
Interior lot line	0'	
Interior lot line of attached CA, RSC or RTT	5'	
Street Type 1	75%	Building Formage min.
Street Type 2	60%	
Street Type 3	N/A	
Street Type 4	N/A	

[NOTE: Delete graphic above]

Figure 17C.123.040-F
Context Area 4 (CA-4)

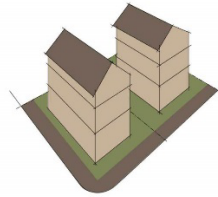

Images above are representational only and are not to be considered regulatory. The Regulatory Plan, this chapter's general provisions and the information contained in the table to the right control over the regulatory framework related to land use, height, parking, setbacks, building form, coverage and formage.

¹ Attached garage or carport entrance is required to be setback twenty feet from the property line.

² See SMC 17C.116.200(2)(f) setbacks regarding the use of front yard averaging.

Roof Height	35 feet	Height max.
Wall Height	25 feet	
Minimum off-street parking	1 space/ dwelling unit	Parking
Landscaping	See Section SMC 17C.200	
Location	See Section SMC 17C.200	Land Uses
Additional Parking Requirements	See Sections SMC 17C.200.100 SMC 17C.200.120 SMC 17C.200.130 SMC 17C.200.145	
Residential	Residential	Build-to-line
Non-Residential	Non-Residential (on ground floor). Non-Residential Development shall have a Residential Component from Residential and be no more than 1,000 of floor area	
Prohibited uses:	All industrial categories Parking garage (except attached), auto repair shops, car wash, car detailing and drive through Alley Auto Repair shops Drive Through Facilities	Setback min.
Street Type 1	None	
Street Type 2	None	
Street Type 3	None	
Street Type 4	None	
Alley	None	
Interior lot line	0'	
Street Type 1	None	Building Formage min.
Street Type 2	60%	
Street Type 3	50%	
Street Type 4	None	

[NOTE: Delete graphic above]

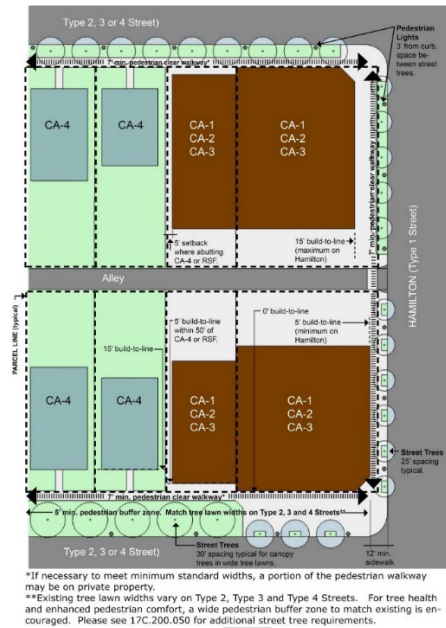

((Figure 17C.123.040-H Visual Diagram))

[NOTE: Delete graphic above]

A. Permitted Uses.

Uses permitted in the residential zones are listed in Table 17C.123.040-1 with a "P." These uses are allowed if they comply with the development standards and other standards of this chapter.

B. Limited Uses.

Uses permitted that are subject to limitations are listed in Table 17C.123.040-1 with an "L." These uses are allowed if they comply with the limitations as listed in the footnotes following the table and the development standards and other standards of this chapter. The paragraphs listed below contain the limitations and correspond with the bracketed [] footnote numbers from Table 17C.123.040-1.

C. Conditional Uses.

Uses that are allowed if approved through the conditional use review process are listed in Table 17C.123.040-1 with a "CU." These uses are allowed provided they comply with the conditional use approval criteria for that use, the development standards, and other standards of this chapter. The conditional use review process and approval criteria are stated in SMC 17C.320, Conditional Uses.

D. Uses Not Permitted.

Uses listed in Table 17C.123.040-1 with an "N" are not permitted. Existing uses in categories listed as not permitted are subject to the standards chapter 17C.210 SMC, Nonconforming Situations.

**Table 17C.123.040-1
Hamilton Form-Based Code Primary Uses**

<u>Use is:</u>	<u>CA1</u>	<u>Shopfront</u>
<u>P – Permitted</u>		
<u>N – Not Permitted</u>		
<u>L – Allowed, but special limitations</u>		
<u>CU – Conditional Use review required</u>		
<u>Residential Categories</u>		
<u>Group Living [1]</u>	<u>L/CU</u>	<u>L/CU</u>
<u>Single-Unit Residential Household Living</u>	<u>N</u>	<u>N</u>
<u>Other Residential Household Living</u>	<u>P</u>	<u>L [2]</u>
<u>Commercial Categories</u>		
<u>Adult Business</u>	<u>N</u>	<u>N</u>
<u>Commercial Outdoor Recreation</u>	<u>N</u>	<u>N</u>
<u>Commercial Parking</u>	<u>N</u>	<u>N</u>
<u>Structured Parking</u>	<u>P</u>	<u>L [3]</u>
<u>Drive-through Facility</u>	<u>N</u>	<u>N</u>
<u>Major Event Entertainment</u>	<u>P</u>	<u>N</u>
<u>Office</u>	<u>P</u>	<u>P</u>
<u>Quick Vehicle Servicing</u>	<u>N</u>	<u>N</u>
<u>Retail Sales and Service</u>	<u>P</u>	<u>P</u>
<u>Mini-storage Facilities</u>	<u>N</u>	<u>N</u>
<u>Vehicle Repair</u>	<u>N</u>	<u>N</u>
<u>Industrial Categories</u>		
<u>High Impact Uses</u>	<u>N</u>	<u>N</u>
<u>Industrial Service</u>	<u>N</u>	<u>N</u>
<u>Manufacturing and Production</u>	<u>N</u>	<u>N</u>
<u>Railroad Yards</u>	<u>N</u>	<u>N</u>
<u>Warehouse and Freight Movement</u>	<u>N</u>	<u>N</u>
<u>Waste-related</u>	<u>N</u>	<u>N</u>
<u>Wholesale Sales</u>	<u>N</u>	<u>N</u>
<u>Institutional Categories</u>		
<u>Basic Utilities</u>	<u>P</u>	<u>N</u>
<u>Colleges [4]</u>	<u>L</u>	<u>L</u>
<u>Community Service</u>	<u>P</u>	<u>P</u>
<u>Daycare</u>	<u>P</u>	<u>P</u>
<u>Medical Center</u>	<u>N</u>	<u>N</u>
<u>Parks and Open Areas</u>	<u>N</u>	<u>N</u>
<u>Religious Institutions</u>	<u>P</u>	<u>P</u>
<u>Schools</u>	<u>P</u>	<u>P</u>
<u>Other Categories</u>		
<u>Agriculture</u>	<u>N</u>	<u>N</u>
<u>Aviation and Surface Passenger Terminals</u>	<u>N</u>	<u>N</u>
<u>Detention Facilities</u>	<u>N</u>	<u>N</u>
<u>Essential Public Facilities</u>	<u>CU</u>	<u>CU</u>

<u>Mining</u>	<u>N</u>	<u>N</u>
<u>Rail Lines and Utility Corridors</u>	<u>N</u>	<u>N</u>
<u>[1] Must comply with the regulations found in SMC 17C.190.100.</u>		
<u>[2] Residential uses are not permitted on the ground floor in Shopfront designated areas.</u>		
<u>[3] Structured parking is not permitted on the ground floor in Shopfront designated areas.</u>		
<u>[4] The accessory uses of housing, retail, and offices are permitted. Lecture halls, food halls, health and sports facilities, laboratories, and other accessory uses not specifically allowed are not permitted within the Hamilton Form-Based Code. Dormitory style housing must comply with the regulations found in SMC 17C.190.100 for group living.</u>		

Section 5. That SMC Section 17C.123.050 is amended to read as follows:

Section 17C.123.050 ((~~Streetscape Requirements~~)) Parking and Pedestrian Connectivity

~~((This section identifies features and specifications for commercial and residential streets and alleys within FBC Limits, keyed to the street types identified in the Street Section Plan and to Shopfront Street areas noted on the Regulating Plan. These criteria work to establish the type of active, economically vibrant public realm sought by the community, balancing vehicular access with the safety and convenience of pedestrians and other non-motorized modes of travel.~~

~~A. — Streetscape Requirements.~~

~~Required streetscape features and dimensions of those elements are identified in Table 17C.123.050-1.))~~

((Table 17C.123.050-1 Streetscape Requirements [1]					
	Type 1	Type 2	Type 3	Type 4	Alley
Sidewalks					
Overall Width (each side)	12' to 22'	12'	12'	12'	N/A
Type	A	A	A	A	N/A
Clear Pedestrian Zone	7'	7'	7'	7'	N/A
Planting Zone (each side)	5'	5'	5'	5'	N/A
[2]					
Street Furnishings					
Lighting, types	P [3]	P [3]	P [3]	P [3]	V
Planting, types	S	S/M	S/M	S	N/A
Benches	R	R	R	N/R	N/A
Trash receptacles	R	R	R	N/R	N/A
Bicycle parking	N/R	N/R	N/R	N/R	N/A

~~[1] See City of Spokane Department of Engineering Design Standards for additional specifications.~~

~~[2] Minimum size; Existing tree lawn widths vary on Type 2, 3 and 4 Streets. Additional setbacks, if any, should match existing tree lawn widths in the CA-4 zone. Please see 17C.200 for additional street tree requirements.~~

~~[3] See Figure 17C.123.050-B (below) for Pedestrian Scale Lighting Standards
Parking Stall types: "A" = 8.5' W x 18' L parallel stalls; "B" = 9' W x 16' L angled stalls, back-in (60°?)~~

~~Sidewalk types: "A" = 4' x 2' scored concrete~~

~~Lighting types: "P" = Pedestrian scale; "V" = Vehicle scale~~

~~Planting types: "S" = Street trees; "M" = Median planting~~

~~Benches, Trash receptacles, Bicycle parking: "R" = Required; "N/R" = Not required))~~

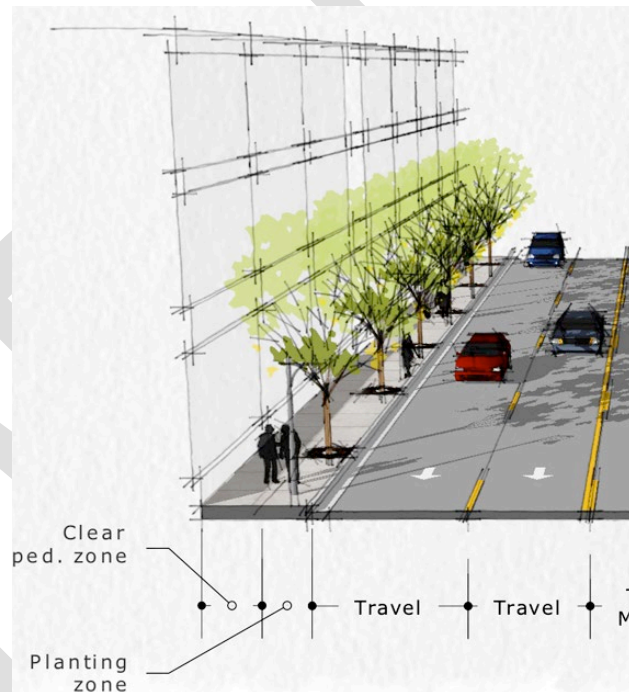

~~((Figure 17C.123.050-A—Desired Frontage Characteristics.))~~

[NOTE: Delete graphic above]

~~((A.—Sidewalks:~~

~~The composition and color of sidewalks shall be as described in Table 17C.123.050-1, and shall be continued as they cross vehicular driveways (See Figure 17C.123.050-E).~~

- ~~1. When the existing sidewalk width is less than 12 feet structures shall be allowed no closer than 12 feet from the back of the curb.~~
- ~~2. When the existing sidewalk width is greater than the bare minimum of 12 feet the sidewalk environment shall be designed to meet the intent of the Street Type designation of the street. Existing sidewalk width shall not be reduced or encroached upon by new development.~~

~~B. Street Furnishings, Placement.~~

~~Street furnishings including light poles, benches, and trash receptacles shall be placed between tree locations within the Planting Zone. Street furnishings shall not impede the clear view triangle. Temporary and intermittent sidewalk encroachments including café seating, planters, ramps, steps, and sandwich board signs may be located in the Planting Zone without restriction, or in the Clear Pedestrian Zone provided a pathway of at least six (6) feet wide remains free of such obstructions (See Figure 17C.123.050-F). Bicycle parking is encouraged where the requirement for the Planting Zone and Clear Pedestrian Zone can be met. Bicycle parking provided in the streetscape can contribute to requirements in SMC 17C.230.200(1)(b). Street furnishings required in Table 17C.123.050-1 are to be provided in all Context Areas as follows:~~

- ~~1. Planting — Street trees must be installed and maintained by the adjacent property in all streets bordering development. Generally, street trees should be spaced on average 25 feet apart. At a minimum, street trees shall provide a continuous row of City-approved trees spaced according to mature canopy size, plus one or more types of City-approved ground cover. Additional requirements for landscaping are stated in chapter 17C.200, Landscaping and Screening.~~
- ~~2. Lighting — City-approved Traditional Series pedestrian scale lighting as shown in Figure 17C.123.050-B (flower basket optional) shall be provided and spaced at an average 50 to 60 feet apart, generally midway between required street trees and centered thirty-six (36") from the curb to ensure a uniform distance from the street edge along the entire street.~~
- ~~3. City approved benches and trash receptacles shall be provided for all buildings larger than 10,000 sf. Buildings less than this size are encouraged to include such amenities.))~~

Hamilton FBC Pedestrian Light Standards

C.1. The City of Spokane Traditional Series pedestrian acorn light (flower basket optional) shall be installed at an average 25' spacing generally spaced midway between street trees and centered thirty-six inches (36") from the curb to ensure a uniform distance from street edge along the entire street.

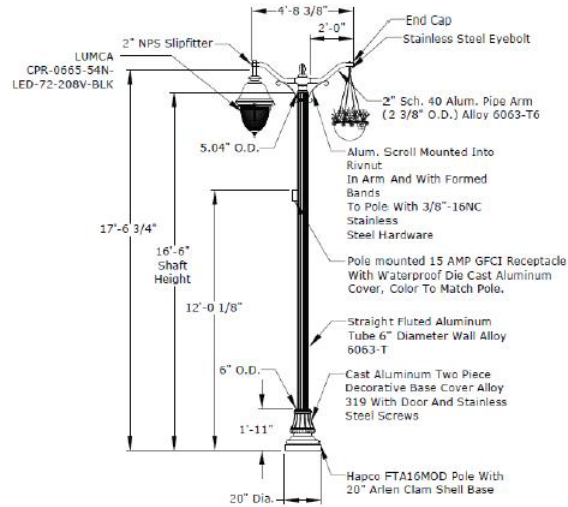

Traditional Series Light Fixture
Not to Scale

((Figure 17C.123.050-B))

[NOTE: Delete graphic above]

DRAFT



((Figure 17C.123.050-E: Curb cuts and driveways may not interrupt sidewalk material and pattern requirements. Ramps may not encroach on Clear Pedestrian Zones.))

[NOTE: Delete graphic above]



((Figure 17C.123.050-F: Temporary sidewalk encroachments are allowed in the Planting Zone, or in the Clear Pedestrian Zone as per Table 17C.123.050-4.))

[NOTE: Delete graphic above]

The Hamilton Form-Based Code (FBC) establishes parking standards that support pedestrian and vehicular movement within and through the area to provide a safe and convenient environment for transit, walking, biking, and rolling.

A. Dimensional standards and other off-street parking requirements are found in SMC 17C.230.200 unless otherwise modified in this chapter.

B. Minimum Parking.

For all uses within the Hamilton FBC area, there are no minimum vehicular off-street parking spaces.

C. Maximum Parking.

A maximum of 2 spaces for every 500 square feet of floor area is permitted.

D. Parking Location.

1. Off-Street Surface Parking.

a. Off-street surface parking shall not be placed between the street right-of-way and the building fronting the street.

2. Shopfront Designated Areas.

If fronting on a Shopfront designation, above-ground parking structures shall provide continuous ground level commercial or office spaces and uses along the street, except at ingress and egress points into the structure. (See Figure 17C.123.040-A).

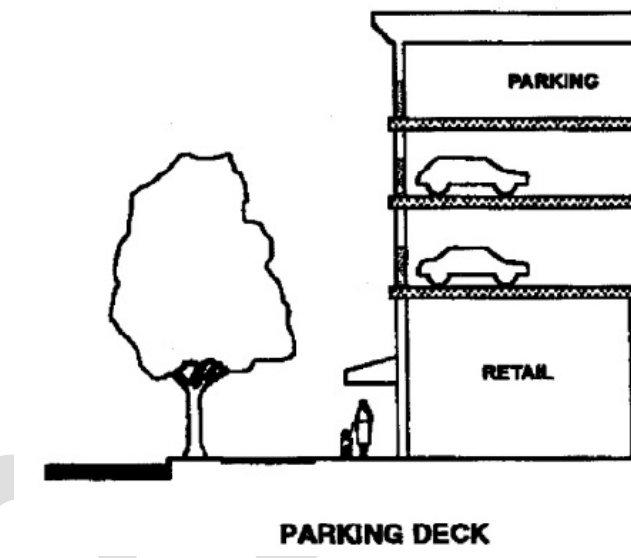

Figure 17C.123.40-A

3. Bicycle Parking.

Requirements for bicycle parking are found in SMC 17C.230.200. Bicycle parking provided in the streetscape can contribute to requirements in SMC 17C.230.200.

4. Site Lighting.

Surface parking lot and site lighting shall contribute to the visibility and safety of the site and adjacent rights-of-way, while not disturbing adjacent properties. Surface lot and site lighting shall adhere to the following standards:

a. Lighting types.

Pedestrian-scale fixtures shall be used for all lighting illuminating required Pedestrian Paths. Vehicle-scale fixtures may be used for general surface lot and site lighting. Lighting shall meet the dimensions of Figure 17C.123.40-B.

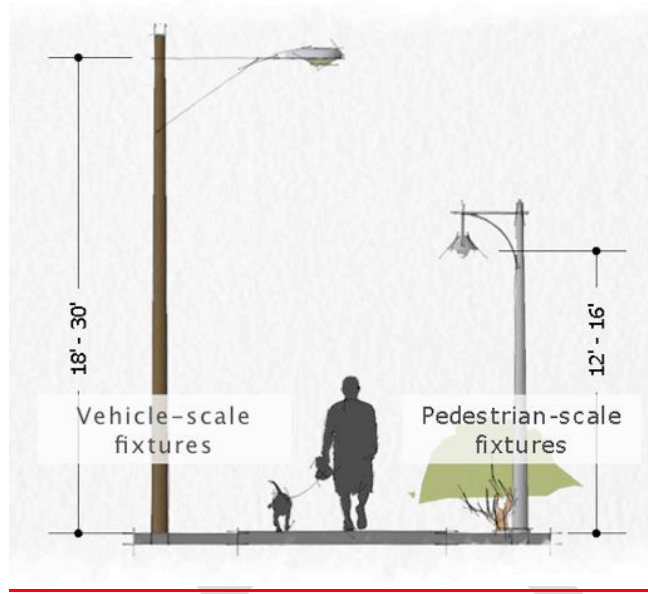

Figure 17C.123.40-B

b. Performance.

Parking lot and site lighting shall provide adequate night visibility and security by distributing a minimum of two foot-candles to a maximum of six foot-candles of illumination at ground level. All lighting shall be shielded from producing off-site glare, directing light downward and away from adjacent properties.

5. Driveways/Site Access.

Driveway widths shall not exceed 24 feet, and curb cuts shall not exceed 30 feet for combined entry/exits.

6. Pedestrian Walkways.

a. Within surface lots containing more than 30 parking stalls, pedestrian-friendly walkways shall be provided between the surface lots and building entrances.

b. Pedestrian Paths shall be not less than five feet wide and be clearly defined, using at least two of the following:

i. Six-inch vertical curbing

ii. Textured paving, including across vehicle lanes

iii. Continuous landscaped area at a minimum of 3 feet wide on at least one side of the walkway.

Section 6. That SMC Section 17C.123.060 is amended to read as follows:

Section 17C.123.060 (~~(Architectural Requirements)~~) Streetscape Requirements

~~((This section identifies general architectural requirements and guidelines, articulating basic façade requirements, roofline objectives, mechanical screening and other considerations. These requirements and guidelines establish important functional and aesthetic characteristics sought by the community and expressed by the Regulating Plan, ensuring the proper “fit” within the surrounding neighborhood.~~

~~A. Building Base.~~

~~For CA-1, CA2, CA3 and all Shopfront Street areas, building façades shall include a visually prominent plinth or base, helping establish pedestrian-scaled features and aesthetically tying the building to the street level. Building bases shall measure between 9” and 16” above adjacent grade, and utilize at least one of the following:~~

- ~~1. “Heavier” material composition, such as a stronger, more permanent material than used on upper portions of the façade.~~
- ~~2. A horizontal projection showing visible thickening of the wall surface that may be accompanied by a change of material and/or color.~~
- ~~3. A horizontal architectural line or feature, such as a belt course or secondary cornice, at or below the top of the first story and providing visual separation between the first two floors (See Figure 17C.123.060-A).~~

~~B. Primary Building Entries.~~

~~For CA-1, CA2, CA3 and all Shopfront Street areas, Primary Building Entries shall face the street and be made visually prominent, including the use of a recommended accent material and at least one of the following:~~

- ~~1. Recessed entrance. Recessed entrance shall be recessed at least 3’ from the building face.~~
- ~~2. Canopy or awning. Canopy or awning shall extend at least 5’ from the building face, with a minimum height clearance of 8’ above the sidewalk.~~
- ~~3. Inclusion of a volume that protrudes from the rest of building surface or an Architectural Roof Structure element physically or visually integrated with the Primary Building Entry (See Figure 17C.123.060-B).~~
- ~~4. For mixed-use buildings, entrances to residential, office or other upper story uses shall be clearly distinguishable in form and location from retail entrances.))~~



~~((Figure 17C.123.060-A: Illustration of building base, pedestrian-scale signs and other building elements described in the FBC.))~~

~~[NOTE: Delete graphic above]~~



~~((Figure 17C.123.060-B: Primary Building Entrances must face the street and be made visually prominent using one or more architectural approaches listed in 17C.123.070-B.))~~

~~[NOTE: Delete graphic above]~~

~~C. Street level Detailing.~~

~~For CA-1, CA2, CA3 and all Shopfront Street areas, street-level façades shall help create a more welcoming, aesthetically rich pedestrian environment by incorporating at least four of the following elements:~~

- ~~1. Canopies or awnings spanning at least 25% of the building façade. Canopy or awning shall extend at least 5' from the building face and shall not be closer than 2' from the curb, with a minimum height clearance of 8' above the sidewalk.~~
- ~~2. Pedestrian-Scaled Signs, mounted to the building or permanent overhang.~~
- ~~3. Decorative sconce, lantern or similar lighting, mounted to the building.~~
- ~~4. Projecting windowsills.~~
- ~~5. Decorative kick plates for entry doors.~~
- ~~6. Hanging planters supported by brackets mounted to the building.~~

~~D. Façade Transparency.~~

~~Building façades shall include substantial glazing, providing visual connectivity between activities inside and outside a building. Regarding glazing, the following provisions shall apply:~~

- ~~1. If fronting along a Shopfront Street, ground floor glazing shall be at least ten feet (10') in height and no more than three feet (3') above adjacent sidewalk or grade.~~
- ~~2. If facing a public street, upper floor façades shall include a minimum of 30% clear glass windows.~~
- ~~3. The total glazing expressed as a minimum percentage of ground floor façades shall meet the specifications provided in Table 17C.123.060-1.~~

Table 17C.123.060-1 Glazing minimums, ground floor facades*				
	CA-1	CA-2	CA-3	CA4
Along Shopfront Street	60%	60%	50%	N/A
Along Non-Shopfront Street	40%	30%	30%	30%
*Glazing percentages may include windows and doors.				

~~E. Blank Walls.~~

~~Minimizing blank or undifferentiated façade walls helps ensure that buildings contribute to an engaging pedestrian environment. In all CA areas, blank façade walls longer than 30' along any public right-of-way shall be enhanced or screened by incorporating the following:~~

- ~~1. Vegetation such as espalier trees and/or vines planted adjacent to the wall surfaces.~~
- ~~2. Architectural detailing, such as reveals, contrasting materials, bas-relief detailing, artwork, murals, or decorative trellises.~~

~~3. Roof Lines.~~

~~F. In all CA areas, roofline elements shall adhere to the following standards:~~

- ~~1. Pitched or sloping roofs shall have a minimum slope of 4:12 and a maximum slope of 12:12 (rise:run).~~
- ~~2. Buildings with flat roofs shall include an extended parapet on all building sides, creating a defined cornice or prominent top edge.~~
- ~~3. Non-Enclosed, Enclosed and Architectural Roof Structure elements as defined by this code in are exempt from sections 17C.123.060 F.1 and~~

~~17C.123.060 F.2. Height limitations for such elements are provided in 17C.123.040.~~

~~G. Equipment Screening.~~

~~In all CA zones visible from public rights-of-way, mechanical and electrical equipment including HVAC units, transformers, antennae and receiving dishes shall be screened from view, adhering to the following standards:-~~

- ~~1. Rooftop mechanical and electrical equipment shall be screened by a parapet wall, enclosed within roof volumes or other building elements designed as an integral part of the building's architecture.~~
- ~~2. Ground-level mechanical and electrical equipment shall be enclosed within secondary building elements, or screened by features designed to coordinate with the architectural character of the primary structure. Picket or chain-link fencing may not be used (See Figure 17C.123.060 C).~~

~~H. Service Area Screening.~~

~~In all CA zones, service, loading and trash collection areas shall be hidden or screened from view along public rights-of-way, and shall not face any public street or residential area unless no other location is possible. Service areas shall be hidden from view using a screen wall constructed of masonry, wood or metal, designed to coordinate with the architectural character of the primary structure. Screen walls shall also include one or more of the following:~~

- ~~1. Vegetation such as espalier trees and/or vines planted adjacent to the wall surfaces.~~
- ~~2. Architectural detailing, such as reveals, contrasting materials, bas-relief detailing, artwork, murals, or decorative trellises.~~

~~I. Sign Standards.~~

~~For sign standards applying to all CA zones, see City of Spokane Municipal Code, Chapter 17C.240. For the purposes of signs standards CA1 and CA2 shall be evaluated as CC1 zone; CA3 shall be evaluated as CC2; and CA4 shall be evaluated as a residential zone.~~

~~J. Materials.~~

~~Use of quality building materials ensures that projects contribute to the overall value and character of properties within and adjacent to HFBC Limits. Buildings shall employ durable and high quality materials, such as steel, glass, brick, stone, and/or wood. (See Figure 17C.123.060 D).))~~

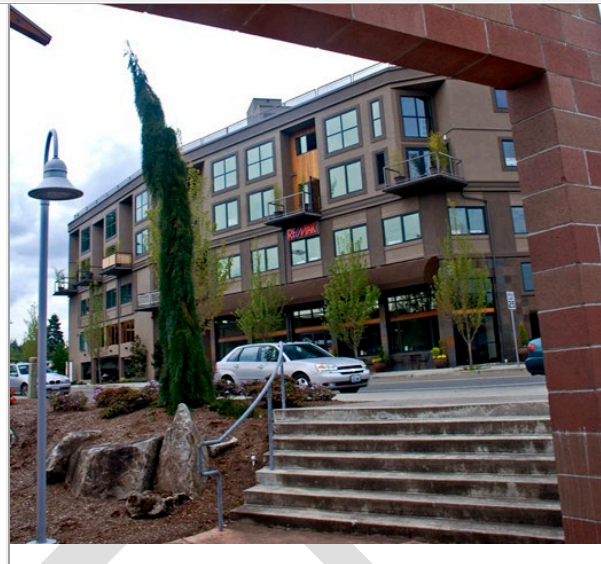
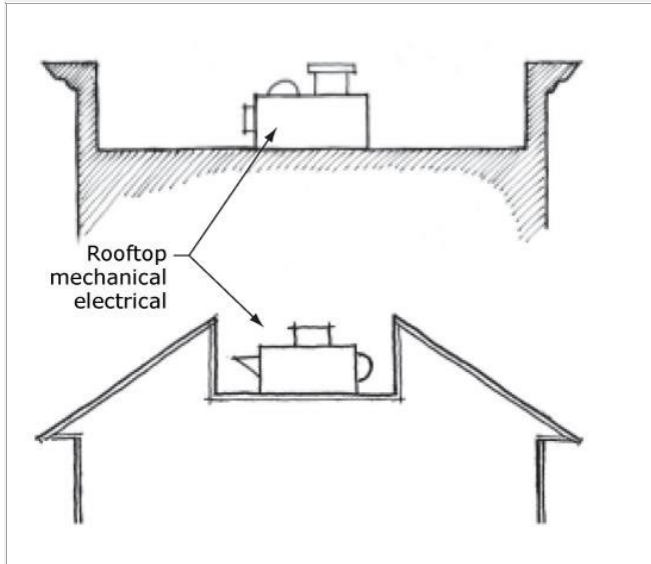

~~((Figure 17C.123.060-C: Rooftop and ground-level equipment must be screened from view along public rights-of-way. Here mechanical systems are hidden by cornice and roof elements.))~~

~~[NOTE: Delete graphic above]~~

~~((Figure 17C.123.060-D: The HFBC provides standards and guidelines regarding building materials, helping realize community expectations for the corridor and neighborhood.))~~

~~[NOTE: Delete graphic above]~~

~~((K.—Guidelines:~~

~~In addition to the material standards defined in this section, the following guidelines are included to further define community expectations for projects within all CA zones within Regulating Plan limits. The guidelines presented in this section are optional and intended to express desirable characteristics for the district.~~

- ~~1.—The use of sustainably harvested, salvaged, recycled-reused products is encouraged wherever possible.~~
- ~~2.—Optional—Recommended entry treatments include special paving materials such as ceramic tile; ornamental ceiling treatments; decorative light fixtures; decorative door pulls, escutcheons, hinges, and other hardware.~~
- ~~3.—Authentic materials and methods of construction should be used to the greatest degree possible. Materials made to simulate higher-value materials and construction types may be used for reasons of economy, but should be durable and closely match the proportions, surface finishes, and colors of the materials they simulate.~~

- ~~4. When veneers are used, detailing and installation should give the appearance of full-depth material, avoiding the exposure of veneer sides, including use of wrap-around corner pieces.~~
- ~~5. The location and spacing of panel or expansion joints should be incorporated into the façade composition. Castings should be shaped to form architectural profiles that create bases, cornices, pilasters and other elements contributing to the façade composition.~~
- ~~6. Cladding and/or accent materials on the primary building should be carried over onto additions, accessory buildings and site features.~~
- ~~7. Recommended cladding materials include:
 - ~~a. Brick. Red brick is characteristic of the Spokane region, although other colors may be used as well. Full size brick veneer is preferable to thin brick tile.~~
 - ~~b. Stone. Granite, limestone, sandstone, and river rock are preferred stone types. Stone veneer and cast stone simulating these types is allowable.~~
 - ~~c. Cast concrete. Precast or exposed site-cast structural concrete is acceptable. Pigments, special aggregates and surface textures should be exploited to achieve architectural effects.~~
 - ~~d. Concrete block. Where used, creativity in selecting block sizes, surface textures, course patterns and colors is encouraged.~~
 - ~~e. Wood. Horizontal sidings such as clapboard, tongue-in-groove, shingles or shakes, or vertical sidings such as board and batten are acceptable. Trim elements should be used for all wood siding types. Heavy timber detailing and exposed bracing may be used where appropriate to the building style.~~
 - ~~f. Fiber cement or cementitious siding. Fiber cement planks, panels and shingles and are an acceptable substitute for wood siding when used in the formats described above under "Wood."~~
 - ~~g. Stucco. Stucco, cement plaster or stucco-like finishes such as EIFS may be used along ground floor portions of rear or side service and parking exposures, provided the building base treatment used along the street façade is continued. Stucco of any type should not be used along ground floor portions of street exposures.~~~~

8. ~~Accent materials are typically used at building entrances, window and door frames, wall bases, cornices, wainscot materials and for copings, trim, and other special elements. Recommended accent materials include:~~
 - a. ~~Brick. Red brick is characteristic of the Spokane region, although other colors may be used as well. Full size brick veneer is preferable to thin brick tile.~~
 - b. ~~Stone. Granite, limestone, sandstone, and river rock are preferred stone types. Stone veneer and cast stone simulating these types is allowable.~~
 - c. ~~Cast concrete. Precast or exposed site-cast structural concrete is acceptable. Pigments, special aggregates and surface textures should be exploited to achieve architectural effects.~~
 - d. ~~Concrete block. Where used, creativity in selecting block sizes, surface textures, course patterns and colors is encouraged.~~
 - e. ~~Tile. Ceramic, terra cotta and cementitious tile, whether glazed or unglazed is acceptable.~~
 - f. ~~Metal. Profile, corrugated and other sheet, rolled or extruded metal is acceptable. Metal accents should have trim elements to protect edges, and be of adequate thickness to resist dents and impacts. Surfaces should be treated with a high quality, fade-resistant coating system or paint such as Kynar and Tnemec. Copper, zinc and weathering steel may be left exposed.~~
9. ~~Rooflines. Varied roof planes, cornice elements, overhanging eave and roof decks are encouraged, as they increase visual interest and help implement desired character objectives.~~
10. ~~Recommended materials for roofs exposed and visible from public rights of way include:~~
 - a. ~~Metal seam roofing. Finishes should be anodized, fluoro-coated or painted. Copper, zinc and weathering steel may be left exposed.~~
 - b. ~~Slate or slate-like materials.~~
 - c. ~~Sheet metal shingles.~~
 - d. ~~Asphalt shingles. Projects using asphalt shingles should use the highest quality commercial grade materials, and be provided with adequate trim elements.~~

- 11. ~~Special Paving. Cobblestones or a stamped concrete cobblestone or brick pattern are recommended for special paving and pedestrian buffer strips~~
- 12. ~~Frontage Types. Figure 17C.123.060E clarifies expectations for how buildings will meet the street.))~~

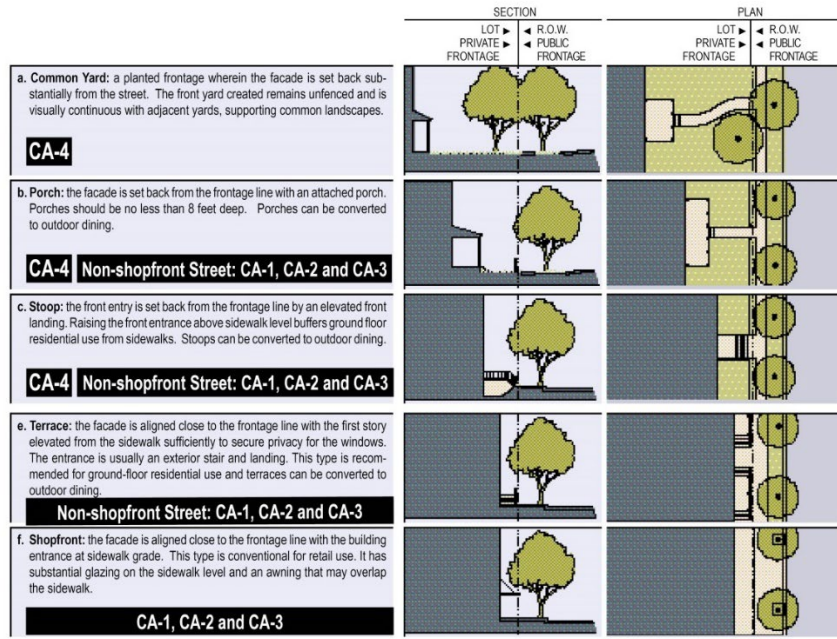

~~((Figure 17C.123.060-E: Frontage Types))~~

[NOTE: Delete graphic above]

This section of the Hamilton Form-Based Code (FBC) identifies features and specifications for area streets and alley. The standards work to establish the type of active, economically vibrant public realm sought by the area community, balancing vehicular access with the safety and convenience of transit, walking, biking, and rolling.

A. Streetscape Requirements.

Required streetscape features and dimensions of those elements are identified in Table 17C.123.050-1.

Table 17C.123.060-1			
Streetscape Requirements [1]			
	CA1	Shopfront	Alley
Sidewalks			
Overall Width (each side)	12 ft.		N/A

Type	4' x 2' scored concrete		N/A
Clear Pedestrian Zone	7 ft. [2]		N/A
Buffer Zone (each side) [3]	5 ft.		N/A
Street Furnishings			
Lighting, types [4]	P	P	V
Planting, types [5]	S	S/M	N/A
Benches [6] [7]	R	R	N/A
Trash receptacles [6] [7]	R	R	N/A
Bicycle parking [6] [7]	N/R	R	N/A
[1] See City of Spokane Department of Engineering Design Standards for additional specifications.			
[2] Along Columbus Street, a 10-foot wide Clear Pedestrian Zone is required.			
[3] A reduced width may be permitted with an approved alternative planting system, such as modular suspended pavement systems, with the approval of Urban Forestry.			
[4] "P" = Pedestrian scale; "V" = Vehicle scale			
[5] "S" = Street trees; "M" = Median planting			
[6] "R" = Required; "N/R" = Not required			
[7] Buildings less than 10,000 sf. are encouraged to include such amenities but are not required.			

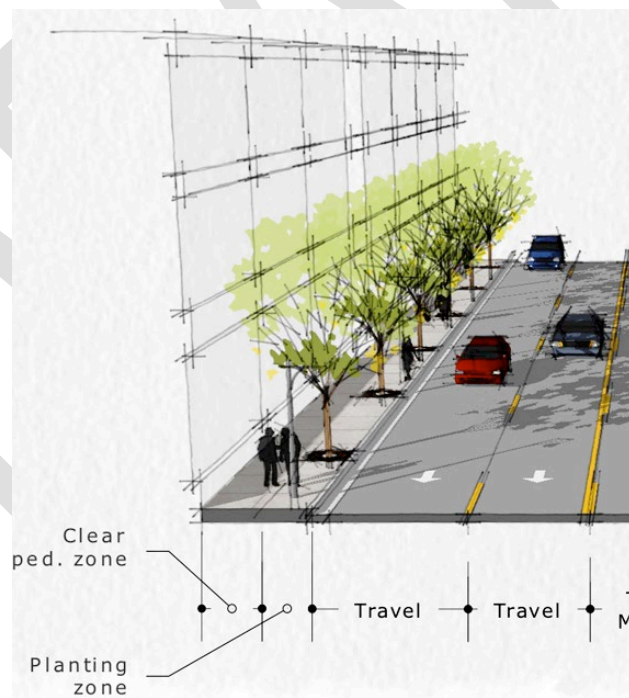

Figure 17C.123.050-A –
Desired Frontage Characteristics.

B. Sidewalks.

The composition and color of sidewalks shall be as described in Table 17C.123.050-1 and shall be continued as they cross-vehicular driveways (See Figure 17C.123.050-B).

1. When the existing sidewalk width is less than 12 feet, structures shall be allowed no closer than 12 feet from the back of the curb.
2. When the existing sidewalk width is greater than the bare minimum of 12 feet, the existing sidewalk width shall not be reduced or encroached upon by new development.

C. Street Furnishings.

Street furnishings including light poles, benches, and trash receptacles shall be placed between tree locations within the Planting Zone. Street furnishings shall not impede the clear view triangle. Street furnishings required in Table 17C.123.050-1 are to be provided as follows:

1. Planting.

Street trees must be installed and maintained by the adjacent property in all streets bordering development. Generally, street trees should be spaced on average 25 feet apart. At a minimum, street trees shall provide a continuous row of City-approved trees spaced according to mature canopy size, plus one or more types of City-approved ground cover. Additional requirements for landscaping are stated in chapter 17C.200 SMC, Landscaping and Screening.

2. Lighting.

City-approved Traditional Series pedestrian scale lighting as shown in Figure 17C.123.050-C (flower basket optional) shall be provided and spaced at an average 50 to 60 feet apart, generally midway between required street trees and centered thirty-six (36") from the curb to ensure a uniform distance from the street edge along the entire street.

Hamilton FBC Pedestrian Light Standards

C.1. The City of Spokane Traditional Series pedestrian acorn light (flower basket optional) shall be installed at an average 25' spacing generally spaced midway between street trees and centered thirty-six inches (36") from the curb to ensure a uniform distance from street edge along the entire street.

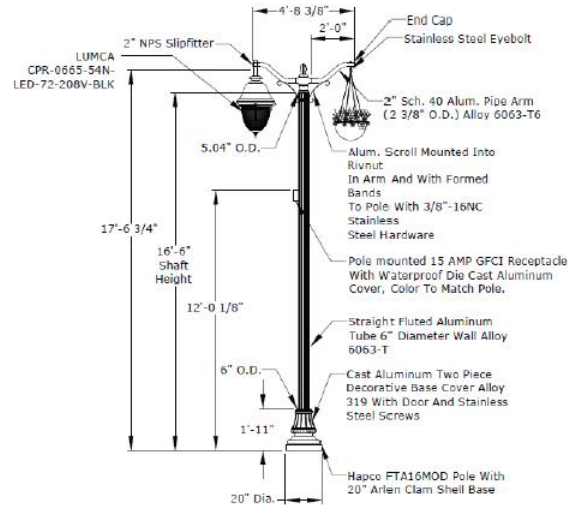

Traditional Series Light Fixture
Not to Scale

Figure 17C.123.050-C

D. Bicycle Parking.

Bicycle parking is encouraged where the requirement for the Planting Zone and Clear Pedestrian Zone can be met. Bicycle parking provided in the streetscape can contribute to requirements in SMC 17C.230.200.

E. Temporary Encroachments.

Temporary and intermittent sidewalk encroachments including café seating, planters, ramps, steps, and sandwich board signs may be located in the Planting Zone without restriction, or in the Clear Pedestrian Zone provided a pathway of at least six (6) feet wide remains free of such obstructions (See Figure 17C.123.050-D).



Figure 17C.123.050-D – Temporary sidewalk encroachments are allowed in the Planting Zone, or in the Clear Pedestrian Zone as per Table 17C.123.050-1.

F. City approved benches and trash receptacles shall be provided for all buildings larger than 10,000 sf. Buildings less than this size are encouraged to include such amenities.

Section 7. That SMC Section 17C.123.070 is amended to read as follows:

Section 17C.123.070 ((Additional Requirements)) Design Standards

~~((A.—Drive Through Facilities:~~

~~Drive-Through Facilities are prohibited in all Context Areas of the FBC.~~

~~B.—Nonconforming Situations:~~

~~Existing development that does not conform to the development standards of this chapter is subject to the standards of chapter 17C.210 SMC, Nonconforming Situations.~~

~~C. Nuisance-related Impacts.~~

- ~~1. Off-site impacts. All nonresidential uses including their accessory uses must comply with the standards of Chapter 17C.220, Off-Site Impacts.~~
- ~~2. Other nuisances are further regulated by state and local laws.~~

~~D. Outdoor Activities~~

- ~~1. The standards of this section are intended to assure that outdoor sales, display, storage, and work activities:~~
 - ~~a. will be consistent with the desired character of the zone;~~
 - ~~b. will not be a detriment to the overall appearance of an area;~~
 - ~~c. will not have adverse impacts on adjacent properties, especially those with residential uses; and~~
 - ~~d. will not have an adverse impact on the environment.~~
- ~~2. Outdoor activities associated with permitted uses shall be permitted subject to the standards of the zone and as described below.~~
- ~~3. Outdoor Sales and Display Areas.~~
 - ~~a. In the CA1—CA3 zones, outdoor sales, and display areas are limited to forty percent of lot area or one thousand five hundred square feet, whichever is less.~~
 - ~~b. Outdoor sales and display areas for uses in the industrial use categories are not allowed in the CA zones.~~
 - ~~c. In the CA 4 zone, outdoor sales and display areas are prohibited.~~
- ~~4. Outdoor Storage Areas.~~
 - ~~a. Outdoor storage areas are not permitted in the CA1—CA3 zones.~~
 - ~~b. Outdoor storage areas in CA4 zones are subject to the standards of SMC 17C.110.270 Exterior Storage—Residential Zones.~~

~~5. Outdoor Activity Area Improvements.~~

- ~~a. Outdoor activities shall be screened and landscaped according to the provisions of chapter 17C.200 SMC, Landscaping and Screening.~~
- ~~b. In order to control dust and mud, all vehicle circulation areas must be paved.~~

~~E. Fences~~

- ~~1. Purpose: The fence standards promote the positive benefits of fences without adversely impacting the community or endangering public or vehicle safety. Fences near streets are kept low in order to allow visibility into and out of the site and to ensure visibility for motorists. Fences in any required side or rear setback are limited in height so as to not conflict with the purpose for the setback.~~
- ~~2. Type of Fences The standards apply to walls, fences, and screens of all types whether open, solid, wood, metal, wire, masonry, or other material.~~
- ~~3. Location, Height, and Design.~~
 - ~~a. Street Setbacks.~~
 - ~~i. No fence or other structure is allowed within twelve feet from the back of the curb, consistent with the required sidewalk width of SMC 17C.123.060.~~
 - ~~ii. Fences up to three and one-half feet high are allowed in a required street setback that is measured from a front lot line.~~
 - ~~iii. Fences up to six feet high are allowed in required setback that is measured from a side lot line.~~
 - ~~iv. Fences shall not reduce the required setback width of SMC 17C.123.060.~~
 - ~~v. Fences up to six feet high are allowed in required side or rear setbacks except when the side or rear setback abuts a pedestrian connection. When the side or rear setback abuts a pedestrian connection, fences are limited to three and one-half feet in height.~~

~~vi. The height for fences that are not in required setbacks is the same as the regular height limits of the zone.~~

~~b. Sight-obscuring Fences and Walls.~~

~~i. Any required or non-required sight-obscuring fences, walls, and other structures over three and one-half feet high, and within fifteen feet of a street lot line shall either be placed on the interior side of a L2 see-through buffer landscaping area at least five feet in depth (See chapter 17C.200 SMC, Landscaping and Screening), or meet the treatment of blank walls intent outlined in SMC 17C.122.060 Initial Design Standards and Guidelines for Center and Corridors.~~

~~4. Prohibited Fences.~~

~~a. No person may erect or maintain a fence or barrier consisting of or containing barbed, razor, concertina, or similar wire except that up to three strands of barbed wire may be placed atop a lawful fence exceeding six feet in height above grade.~~

~~b. No person may maintain a fence or barrier charged with electricity.~~

~~c. A fence, wall, or other structure shall not be placed within a public right-of-way without an approved covenant as provided in SMC 17G.010.160 and any such structure is subject to the height requirement for the adjoining setback.~~

~~d. No permanent fence may reduce the required sidewalk width.~~

~~5. Visibility at Intersections.~~

~~a. A fence, wall, hedge, or other improvement may not be erected or maintained at the corner of a lot so as to obstruct the view of travelers upon the streets~~

~~b. Subject to the authority of the traffic engineer to make adjustments and special requirements in particular cases, no fence exceeding a height of thirty-six inches above the curb may be inside the:~~

~~i. right isosceles triangle having sides of fifty feet measured along the curb line of each intersecting residential street; or~~

~~ii. right triangle having a fifteen-foot side measured along the curb line of the residential street and a seventy-five-foot side along the curb line of the intersecting arterial street, except~~

~~that when the arterial street has a speed limit of thirty-five miles per hour, the triangle has a side along such arterial of one hundred twenty-two feet; or~~

~~iii. right isosceles triangle having sides of seven feet measured along the right-of-way line of an alley and:~~

~~1. the inside line of the sidewalk; or~~

~~2. if there is no sidewalk, a line seven feet inside the curb line.~~

~~6. Enclosures for Pools, Hot Tubs, or Ponds.~~

~~a. A person maintaining a swimming pool, hot tub, pond, or other impoundment of water exceeding five thousand gallons and eighteen inches or more in depth and located on private property is required to construct and maintain an approved fence by which the pool or other water feature is enclosed and inaccessible by small children.~~

~~b. The required pool enclosure must be at least fifty-four inches high and may be a fence, wall, building, or other structure approved by the building services department.~~

~~c. If the enclosure is a woven wire fence, it is required to be built to discourage climbing.~~

~~d. No opening, except a door or gate may exceed four inches in any dimension.~~

~~e. Any door or gate in the pool enclosure, except when part of the occupied dwelling unit, must have self-closing and self-locking equipment by which the door or gate is kept secure when not in use. A latch or lock release on the outside of the door or gate must be at least fifty-four inches above the ground.~~

~~f. Outside of the door or gate must be at least fifty-four inches above the ground.~~

~~7. Reference to Other Standards.~~

~~1. Building permits are required by the building services department for all fences including the replacement of existing fences. A permit is not required to repair an existing fence.~~

~~F. Creation of new lots is subject to the standards of chapter 17G.080 SMC.))~~

All development within the Hamilton Form-Based Code (FBC) must address the following design standards, administered pursuant to SMC 17C.111.015 Design Standards Administration. When existing development is expanded, only those portions of the development that are new or renovated must meet the standards in this section.

This section also includes Guidelines that further define community desires for new development and redevelopment within the Hamilton FBC area. The Guidelines are optional and intended to express the desired built form for the area.

A. Building Base.

Building façades shall include a visually prominent plinth or base, helping establish pedestrian-scaled features and aesthetically tying the building to the street level. Building bases shall measure between 9 inches and 16 inches above adjacent grade, and utilize at least one of the following:

1. A horizontal projection of at least 3 inches that may be accompanied by a change of material and/or color.
2. A horizontal architectural line or feature, such as a belt course or secondary cornice, at or below the top of the first story and providing visual separation between the first two floors (See Figure 17C.123.060-A).

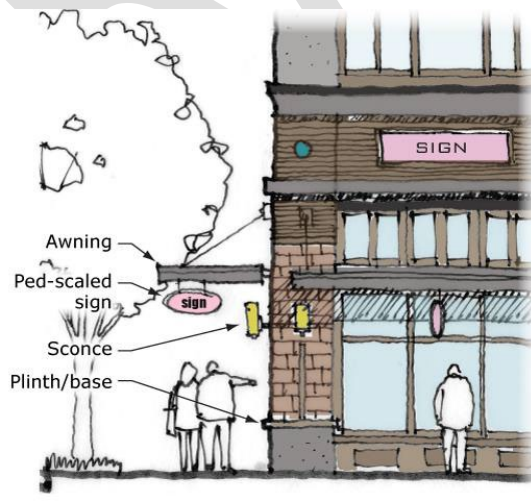

Figure 17C.123.060-A – Illustration of building base, pedestrian scale signs and other building elements described in the FBC.

B. Primary Building Entries.

1. Primary building entries shall face the street and be made visually prominent, including at least one of the following:
 - a. An entrance recessed at least 3' from the building face.
 - b. A canopy or awning that extends at least 5' from the building face, with a minimum height clearance of 8' above the sidewalk.
2. For mixed-use buildings, entrances to residential, office or other upper story uses shall be clearly distinguishable in form and location from retail entrances.

C. Street-level Detailing.

Street-level façades shall help create a more welcoming, aesthetically rich pedestrian environment by incorporating at least four of the following elements:

1. Canopies or awnings spanning at least 25% of the building façade.
2. Canopy or awning shall extend at least 5' from the building face and shall not be closer than 2' from the curb, with a minimum height clearance of 8' above the sidewalk.
3. Pedestrian-Scaled Signs, mounted to the building or permanent overhang.
4. Decorative sconce, lantern, or similar lighting, mounted to the building.
5. Projecting windowsills.
6. Decorative kick plates for entry doors.
7. Hanging planters supported by brackets mounted to the building.

D. Façade Transparency.

Building façades shall include substantial glazing, providing visual connectivity between activities inside and outside a building. Regarding glazing, the following provisions shall apply:

1. If within a Shopfront Designation, ground floor glazing facing a public right-of-way shall be at least ten feet (10') in height and no more than three feet (3') above adjacent sidewalk or grade.
2. The total glazing expressed as a minimum percentage of ground floor façades shall meet the specifications provided in Table 17C.123.060-1.

Table 17C.123.070-1		
Glazing minimums, ground floor facades [1]		
	CA1	Shopfront
<u>Non-Residential – within 10-ft. of the sidewalk</u>	<u>40%</u>	<u>60%</u>

<u>Non-Residential – more than 10-ft. from the sidewalk</u>	<u>15%</u>	<u>15%</u>
<u>Residential</u>	<u>15%</u>	<u>15%</u>
<u>[1] Glazing percentages may include windows and doors.</u>		

E. Ground Floor Residential.

In addition to other standards specific to residential development found within this chapter and in order to increase the privacy of residents and provide an effective transition between the public and private realm, ground floor residential within 10-ft. of a sidewalk shall:

1. Be elevated a minimum of 30 inches from grade, with alternatives approved by the Planning Director to accommodate units meeting residential visitability standards found in SMC 17C.111.600;
2. Incorporate a patio, porch, deck, or stoop with covered entry between the entry and sidewalk; and
3. Integrate L3 Open Area Landscaping, as defined in SMC 17C.200.030 Landscape Types, between the sidewalk and building.

F. Blank Walls.

Minimizing blank or undifferentiated façade walls helps ensure that buildings contribute to an engaging pedestrian environment. Blank façade walls longer than 30' along any public right-of-way shall be enhanced or screened by incorporating the following:

1. Public art such as murals;
2. Vegetation such as espalier trees and/or vines planted adjacent to the wall surfaces;
3. Architectural detailing, such as reveals, contrasting materials, bas-relief detailing, or decorative trellises; or
4. Roof Lines.

G. Roof Lines.

1. Pitched or sloping roofs shall have a minimum slope of 4:12 and a maximum slope of 12:12 (rise:run).
2. Buildings with flat roofs shall include an extended parapet on all building sides, creating a defined cornice or prominent top edge.
3. Non-Enclosed, Enclosed, and Architectural Roof Structure elements as defined by this code are exempt from sections 17C.123.060(G)(1) and 17C.123.060(G)(2). Height limitations for such elements are provided in Table 17C.123.030-1.

H. Equipment Screening.

Mechanical and electrical equipment including HVAC units, transformers, antennae and receiving dishes visible from public rights-of-way shall be screened from view, adhering to the following standards:

1. Rooftop mechanical and electrical equipment shall be screened their full height by a parapet wall, enclosed within roof volumes or other building elements designed as an integral part of the building's architecture.
2. Ground-level mechanical and electrical equipment shall be enclosed within secondary building elements or screened by features designed to coordinate with the architecture of the primary structure. Year-round vegetative screening the height of the equipment at planting is permitted. Picket or chain-link fencing may not be used (See Figure 17C.123.060-B).

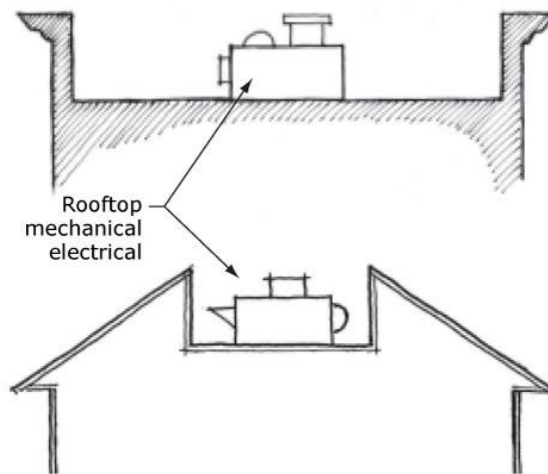

Figure 17C.123.060-B – Rooftop and ground-level equipment must be screened from view along public rights-of-way. Here mechanical systems are hidden by cornice and roof elements.

I. Service Area Screening.

Service, loading, and trash collection areas shall be hidden or screened from view along public rights-of way and shall not face any public street or residential area unless no other location is possible. Service areas shall be hidden from view using a screen wall constructed of masonry, wood, or metal, designed to coordinate with the architecture of the primary structure. Screen walls shall also include one or more of the following:

1. Vegetation such as espalier trees and/or vines planted adjacent to the wall surfaces.
2. Architectural detailing, such as reveals, contrasting materials, bas-relief detailing, or decorative trellises.
3. Public art such as murals.

J. Sign Standards.

See City of Spokane Municipal Code, Chapter 17C.240 for sign standards. Signs within the CA zone are subject to the standards and guidelines contained in the Initial Design Standards and Guidelines for Centers and Corridors.

- K. Swimming pool, hot tub, pond, or other impoundment of water exceeding five thousand gallons and eighteen inches or more in depth must be located within a fully enclosed building.

L. Guidelines.

In addition to the material standards defined in this section, the following guidelines are included to further define community expectations for projects within the Hamilton FBC area. The guidelines presented in this section are optional and intended to express desirable characteristics for the district.

1. Sustainable Design.

- a. The use of sustainably harvested, salvaged, recycled, and reused products is encouraged wherever possible.
- b. The rehabilitation of older buildings should be considered before new construction. If removal is required, the deconstruction of existing development is encouraged.
- c. Integration of Green Stormwater Infrastructure (GSI) should be considered in conjunction with property redevelopment.
- d. Property owners are encouraged to replace or reduce ground cover like grass lawns and pavement with native and/or drought tolerant plantings.
- e. The installation and maintenance of green roofs is encouraged.

2. Trail-Oriented Development.

For properties along the Centennial Trail, development is encouraged to orient towards the trail, which can be accomplished by:

- a. Having patios and decks that overlook the trail.
- b. Having an increased level of façade transparency to increase “eyes on the trail”.
- c. Having a covered entry facing the trail.

d. Avoiding tall fences and blank walls facing the trail.

3. Building Entries.

Recommended entry treatments include special paving materials such as ceramic tile; ornamental ceiling treatments; decorative light fixtures; decorative door pulls, escutcheons, hinges, and other hardware.

4. Building Materials.

a. Authentic materials and methods of construction should be used to the greatest degree possible. Materials made to simulate higher-value materials and construction types may be used for reasons of economy, but should be durable and closely match the proportions, surface finishes, and colors of the materials they simulate.

b. When veneers are used, detailing and installation should give the appearance of full-depth material, avoiding the exposure of veneer sides, including the use of wrap-around corner pieces.

c. Cladding and/or accent materials on the primary building should be carried over onto additions, accessory buildings, and site features.

d. Recommended cladding materials include:

i. Brick. Red brick is characteristic of the Spokane region, although other colors may be used as well. Full size brick veneer is preferable to thin brick tile.

ii. Stone. Granite, limestone, sandstone, and river rock are preferred stone types. Stone veneer and cast stone simulating these types is allowable.

iii. Cast concrete. Precast or exposed site-cast structural concrete is acceptable. Pigments, special aggregates, and surface textures should be exploited to achieve architectural effects.

iv. Concrete block. Where used, creativity in selecting block sizes, surface textures, course patterns and colors is encouraged.

v. Wood. Horizontal sidings such as clapboard, tongue-in-groove, shingles or shakes, or vertical sidings such as board and batten are acceptable. Trim elements should be used for all wood siding types. Heavy timber detailing and exposed bracing may be used where appropriate to the building style.

vi. Fiber-cement or cementitious siding. Fiber-cement planks, panels and shingles and are an acceptable substitute for

wood siding when used in the formats described above under "Wood."

- vii. Stucco. Stucco, cement plaster or stucco-like finishes such as EIFS may be used along ground floor portions of rear or side service and parking exposures, provided the building base treatment used along the street façade is continued. Stucco of any type should not be used along ground floor portions of street exposures.
- e. Accent materials are typically used at building entrances, window and door frames, wall bases, cornices, wainscot materials and for copings, trim, and other special elements. Recommended accent materials include:
 - i. Brick. Red brick is characteristic of the Spokane region, although other colors may be used as well. Full size brick veneer is preferable to thin brick tile.
 - ii. Stone. Granite, limestone, sandstone, and river rock are preferred stone types. Stone veneer and cast stone simulating these types is allowable.
 - iii. Cast concrete. Precast or exposed site-cast structural concrete is acceptable. Pigments, special aggregates and surface textures should be exploited to achieve architectural effects.
 - iv. Concrete block. Where used, creativity in selecting block sizes, surface textures, course patterns and colors is encouraged.
 - v. Tile. Ceramic, terra cotta and cementitious tile, whether glazed or unglazed is acceptable.
 - vi. Metal. Profile, corrugated and other sheet, rolled or extruded metal is acceptable. Metal accents should have trim elements to protect edges, and be of adequate thickness to resist dents and impacts. Surfaces should be treated with a high quality, fade-resistant coating system or paint such as Kynar and Tnemec. Copper, zinc and weathering steel may be left exposed.
- f. The location and spacing of panel or expansion joints should be incorporated into the façade composition. Castings should be shaped to form architectural profiles that create bases, cornices, pilasters and other elements contributing to the façade composition.

5. Rooflines.

Varied roof planes, cornice elements, overhanging eave and roof decks are encouraged, as they increase visual interest and help implement desired character objectives.

a. Recommended materials for roofs exposed and visible from public rights of way include:

i. Metal seam roofing. Finishes should be anodized, fluoro-coated or painted. Copper, zinc and weathering steel may be left exposed.

ii. Slate or slate-like materials.

iii. Sheet metal shingles.

iv. Asphalt shingles. Projects using asphalt shingles should use the highest quality commercial grade materials and be provided with adequate trim elements.

6. Special Paving.

Cobblestones or a stamped concrete cobblestone or brick pattern are recommended for special paving and pedestrian buffer strips.

Section 8. That SMC Section 17C.123.080 is amended to read as follows:

Section 17C.123.080 ((~~Building Type Catalogs~~)) Additional Requirements

A. Outdoor Activities

The standards of this section are intended to assure that outdoor sales, display, storage, and work activities will not have adverse impacts on adjacent properties or the environment, while providing the envisioned built form within the area.

1. Outdoor Sales and Display Areas.

a. Outdoor sales and display areas are limited to forty percent of lot area or one thousand five hundred square feet, whichever is less, in the CA1 zone.

b. Outdoor sales and display areas for uses in the industrial use categories are not allowed in the CA1 zone.

c. In the Shopfront designations, accessory outdoor sales are permitted so long as the Clear Pedestrian Zone and Buffer Zone is maintained.

d. In the Shopfront designations, outdoor display areas are prohibited.

2. Outdoor Storage Areas.

a. Outdoor storage areas are not permitted.

3. Outdoor Activity Area Improvements.

- a. Outdoor activities shall be screened and landscaped according to the provisions of chapter 17C.200 SMC, Landscaping and Screening.
- b. In order to control dust and mud, all vehicle circulation areas must be paved.

B. Fences.

The fence standards avoid adverse impacts on the area while protecting public or vehicle safety. Fences near streets are kept low in order to allow visibility into and out of the site and to ensure visibility for motorists. Fences in any required side or rear setback are limited in height so as to not conflict with the purpose for the setback.

1. Type of Fences.

The standards apply to walls, fences, and screens of all types whether open, solid, wood, metal, wire, masonry, or other material.

2. Location, Height, and Design

a. Street Setbacks.

- i. No fence or other structure is allowed within twelve feet from the back of the curb, consistent with the required sidewalk width of SMC 17C.123.050.
- ii. Fences up to three and one-half feet high are allowed in a required street setback.
- iii. Fences up to six feet high are allowed in required side or rear setbacks except when the side or rear setback abuts a pedestrian connection. When the side or rear setback abuts a pedestrian connection, fences are limited to three and one-half feet in height.
- iv. Fences shall not reduce the required setback width of SMC 17C.123.030.

b. Sight-obscuring Fences and Walls.

- i. Any required or non-required sight-obscuring fences, walls, and other structures over three and one-half feet high, and within fifteen feet of a street lot line shall either be placed on the interior side of a L2 see-through buffer landscaping area at least five feet in depth (See chapter 17C.200 SMC, Landscaping and Screening), or meet the treatment of blank

walls intent outlined in SMC 17C.122.060 – Initial Design Standards and Guidelines for Center and Corridors.

c. Fencing Material.

- i. Fence materials within the public right-of-way or within eight feet of a street lot line should be wrought iron or similar in appearance, aluminum, metal, or similar material.
- ii. Walls visible from streets shall be masonry, stone, brick, or similar construction.
- iii. Chain link fencing is not allowed that is visible from and/or adjacent to a public street.

3. Prohibited Fences.

- a. No person may erect or maintain a fence or barrier consisting of or containing barbed, razor, concertina, or similar wire.
- b. No person may maintain a fence or barrier charged with electricity.
- c. A fence, wall, or other structure shall not be placed within a public right-of-way without an approved covenant as provided in SMC 17G.010.160 and any such structure is subject to the height requirement for the adjoining setback.
- d. No permanent fence may reduce the required sidewalk width.

4. Visibility at Intersections.

A fence, wall, hedge, or other improvement may not be erected or maintained at the corner of a lot so as to obstruct the view of travelers upon the streets.

- 6. Subject to the authority of the traffic engineer to make adjustments and special requirements in particular cases, no fence exceeding a height of thirty-six inches above the curb may be located within the Clear View Triangle, as defined in Section 17A.020.030 “C” Definitions.

Context Area 1 (CA-1)

Hamilton FBC Building Character Visual Catalog

This visual catalog showcases the type, form, and general character of desired development within Context Area 1. Images are representational only.



CA-1 Non-Shopfront

See also CA-2, CA-3 and CA-4 Non-Shopfront.



CA-1 Corner

See also CA-2 and CA-3 Corner.



CA-1 Shopfront

See also CA-2 and CA-3 Shopfront.



CA-1 - 1 to 5 Story Buildings

[NOTE: Delete graphic above]

Context Area 2 (CA-2)

Hamilton FBC Building Character Visual Catalog

This visual catalog showcases the type, form, and general character of desired development within Context Area 2. Images are representational only.



CA-2 Non-Shopfront

See also CA-3 and CA-4 Non-Shopfront.



CA-2 Corner

See also CA-3 Corner.

CA-2 Shopfront

See also CA-3 Shopfront.



CA-2 - 1 to 4 Story Buildings

[NOTE: Delete graphic above]

Context Area 3 (CA-3)

Hamilton FBC Building Character Visual Catalog

This visual catalog showcases the type, form, and general character of desired development within Context Area 3. Images are representational only.



CA-3 Non-Shopfront

See also CA-4.



CA-3 Corner



CA-3 Shopfront



CA-3 - 1 to 2 Story Buildings

[NOTE: Delete graphic above]

Context Area 4 (CA-4)

Hamilton FBC Building Character Visual Catalog

This visual catalog showcases the type, form, and general character of desired development within Context Area 4. Images are representational only.

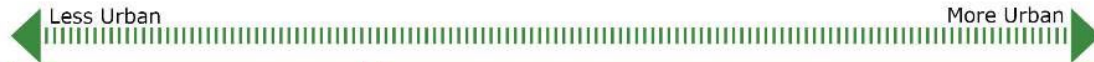

CA-4 Small Footprint



CA-4 Medium Footprint



[NOTE: Delete graphic above]

Context Area 4 (CA-4)

Hamilton FBC Building Character Visual Catalog

This visual catalog showcases the type, form, and general character of desired development within Context Area 4. Images are representational only.



CA-4 Large Footprint



Image borrowed from daybreakutah.com



Image borrowed from daybreakutah.com

[NOTE: Delete graphic above]